

HALFEN HTA ANCHOR CHANNELS

TECHNICAL PRODUCT INFORMATION



HALFEN ANCHOR CHANNELS

HTA 16.1-US

CONCRETE



ICC-ES Approved



HALFEN HTA 5542 10" is bubbled for convenience

See Pages 10,12,19,30

HALFEN HTA Anchor Channels

advantages at a glance

In addition to excellent adjustability, HALFEN Anchor Channels save considerable installation time. The result: faster construction and therefore reduced overall cost.

Safe and reliable

- Installation requires no welding
- No damage to the reinforcement
- ICC-ESR 1008 - Evaluation Report from ICC-ES means acceptance by building authorities across the USA
- Approved loads
- Precise calculation with user-friendly HALFEN Software

Quick and economical

- Adjustable anchoring
- Eliminates the need for field welding
- Cost effective installation using standard tools
- Quick and effortless installation
- Wide product range to accommodate all project requirements
- Eliminates noise, dust and vibration associated with post-installed drilling



HALFEN HTA Anchor Channels
Cold formed



HALFEN HTA Anchor Channels
Hot rolled

*Many advantages with one result:
HALFEN provides safety, reliability and
efficiency for you and your customers.*



ICC-ES Approved



HALFEN USA Inc. • 8521 FM 1976 • TX 78109
Phone: + 1 800.423.9140 • www.halfenusa.com • info@halfenusa.com

HALFEN HTA ANCHOR CHANNELS

Contents



HALFEN HTA Anchor Channels

- Main Features / Advantages at a Glance	4
- Application Examples	5
- Anchor Channel Dimensions	6
- Material / Corrosion Protection	7-8
- Calculation Method according to AC232	9
- Product Overview and Load Capacities	10-17
- Supplementary Reinforcement according to ACI 318-14	18
- HALFEN HS T-bolts	19-24
- Calculation Software	25-26

HALFEN HTA Anchor Channels – General Information

- Installation of Anchor Channels	27-28
- Installation of HS T-bolts	29-30
- Engineering Form	31

HALFEN HTA ANCHOR CHANNELS

Main Features / Advantages at a Glance

Main Features

HALFEN HTA Anchor Channels and HS T-bolts work in tandem to provide a reliable, durable and adjustable connection to concrete. HALFEN Anchor Channels are cast into concrete, eliminating the need for post-installed anchors and field welding. This minimizes the potential to damage the concrete or reinforcement during drilling.

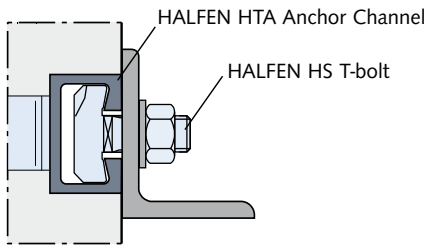

HALFEN Anchor Channels and T-bolts are available in a wide range of profile sizes/diameters and lengths allowing them to be utilized for a wide variety of applications within the construction industry. The system is available in hot-dip galvanized and stainless steel to ensure long lasting performance. Engineered to the highest American standards, HALFEN Anchor Channel system is a proven safe, simple and cost effective method of anchorage to concrete.

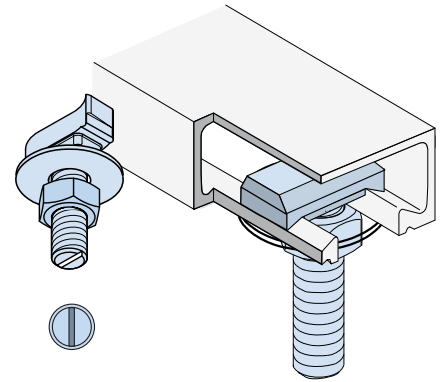

The notch on the T-bolt provides visual confirmation of T-bolt orientation; the final notch position must be at 90° to the channel's longitudinal direction.

Advantages at a Glance

HALFEN Anchor Channels offer the following advantages compared to traditional anchoring methods:

- Extremely short installation time
- Easily adjustable connections
- No welding needed on site
- Allows for construction tolerances
- No specialized workers needed for installation
- Single tool installation (torque wrench)
- No electrical power required during installation
- No on-site corrosion protection needed
- High quality materials and quality galvanization protect components from corrosion
- Visual check is sufficient to confirm correct installation
- Noise, vibration and dust free installation



HALFEN HTA ANCHOR CHANNELS

Application Examples



CURTAIN WALL

LA Live, Los Angeles/CA



CURTAIN WALL

Connection of Curtain Wall to slab



CURTAIN WALL

Museum Tower, Dallas /TX



ELEVATOR CONNECTIONS

Guide rail connection



MASONRY CONNECTIONS Appalachian State University, Boone/NC



MASONRY CONNECTIONS

Installation



STADIUMS

Seat fixing – St. Jakob-Park, Basel/Switzerland



BRIDGES

Connection of the drainage system

HALFEN HTA ANCHOR CHANNELS

General Information

HALFEN HTA Anchor Channel Dimensions

HALFEN HTA Anchor Channel

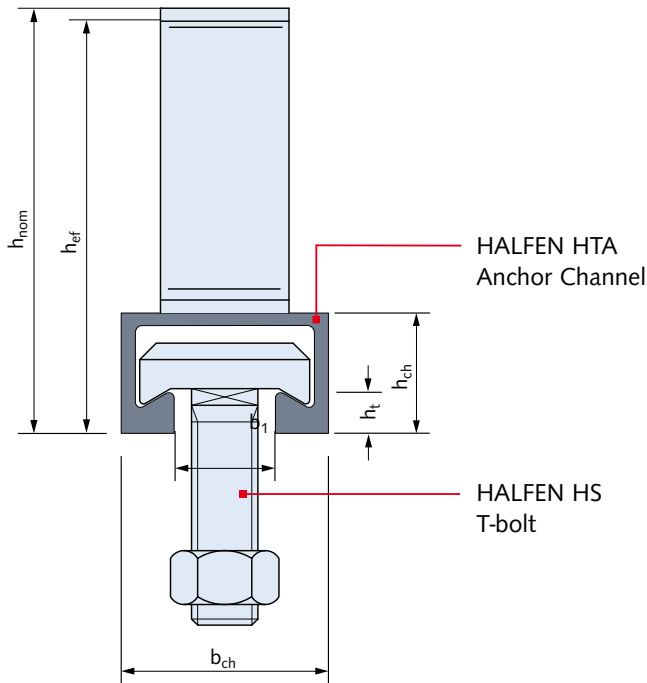

- h_{nom} = Installation height
- h_{ef} = Effective embedment depth
- h_{ch} = Channel height
- b_{ch} = Channel width
- b_1 = Channel opening
- h_t = Height of the channel lips

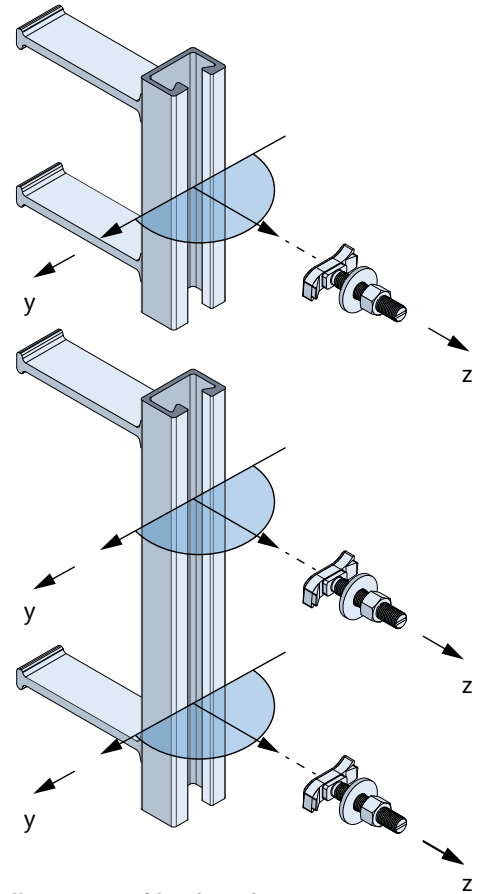
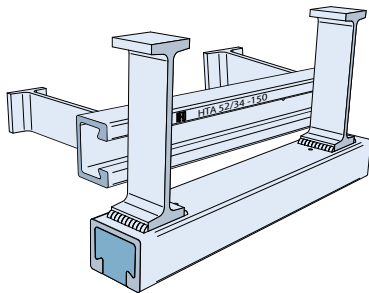

Illustration of loading directions

tension load: z-direction (in direction of anchor)
shear load: y-direction (perpendicular to longitudinal axis of channel)

Identification



Channel material	Type identification
HDG - Hot-dip galvanized carbon steel	HTA (Profile)-(length in mm) e.g. HTA 52/34-250
A4 - Stainless steel	HTA (Profile)-A4 e.g. HTA 52/34-A4

Type identification:

The Anchor Channel description is found on the anchor channel lip.
 This guarantees identification of the product before and after installation.

HALFEN HTA ANCHOR CHANNELS

Materials / Corrosion Protection

Hot-dip galvanized (HDG)

Dipped in a galvanizing bath at a temperature of approx. 860°F (460°C), a method used primarily for open-profile channels.



Electro plated (EP)

HALFEN T-bolts are electrogalvanized and coated with a Cr^{VI}-free thick layer passivation.



HALFEN Anchor Channels, steel, hot-dip galvanized

		Steel		
		Material	Standard	Zinc coat
	 Channel profile	Carbon steel	<input type="checkbox"/> DIN EN 10 025-2 ①	HDG: ≥ 55 µm
	 Bolt anchor B6	Carbon steel	<input type="checkbox"/> DIN EN 10 263 or DIN EN 10 269	HDG: ≥ 55 µm
	 Weld-on anchor	Carbon steel	<input type="checkbox"/> DIN EN 10 025-2	HDG: ≥ 55 µm

① Steel according to DIN EN 10 025-2 and HALFEN specification

HALFEN T-bolts, galvanized steel

		Steel		
		Material/Grade	Standard	Zinc coat
	 T-bolt	Grade 4.6 or 8.8	<input type="checkbox"/> ISO 898-1 and ISO 4034 <input checked="" type="checkbox"/> (similar to ASTM F68M)	HDG ≥ 50 µm EP: ≥ 12 µm
	 Hexagonal nut	Property class 5 or 8	<input type="checkbox"/> ISO 898-2 and ISO 4032 <input checked="" type="checkbox"/> (similar to ASTM F63M)	HDG: ≥ 50 µm EP: ≥ 12 µm
	 Washer	Production class A, 200HV	<input type="checkbox"/> ASTM F844 <input checked="" type="checkbox"/>	HDG: ≥ 40 µm EP: ≥ 12 µm

Stainless steel A4

Chromium is the most important alloy element in stainless steel. A specific chromium concentration ensures the generation of a passive layer on the surface of the steel that protects the base material against corrosion. This explains the high corrosion resistance of stainless steel.

Materials:

- MF** = Steel mill finished
- HDG** = Steel hot-dip galvanized
- EP** = Steel zinc plated (with special coating)
- A4** = Steel, stainless

HALFEN Anchor Channels, stainless steel

		Stainless steel	
		Material/Grade	Standard
	 Channel profile	Stainless steel A4 (similar to 316Ti) <input checked="" type="checkbox"/>	DIN EN10 088 (similar to ASTM A276/A276M)
	 Bolt anchor B6	Stainless steel A4 (similar to 316Ti) <input checked="" type="checkbox"/>	DIN EN10 088 (similar to ASTM A276/A276M)
	 Weld-on anchor	Stainless steel A4 (similar to 316Ti) <input checked="" type="checkbox"/> Steel ② <input type="checkbox"/>	DIN EN10 088 (similar to ASTM A276/A276M) DIN EN10 025-2

HALFEN T-bolts, stainless steel

		Stainless steel	
		Material/Grade	Standard
	 T-bolt	Stainless steel A4 (similar to 316Ti) <input checked="" type="checkbox"/>	ISO 3506-1 (similar to ASTM A276/A276M)
	 Hexagonal nut	Stainless steel A4 (similar to 316Ti) <input checked="" type="checkbox"/>	ISO 3506-2 (similar to ASTM A276/A276M)
	 Washer	Stainless steel A4 (similar to 316Ti) <input checked="" type="checkbox"/>	ISO 7089 and ISO 7093-1

② Corrosion protection of mill finished anchor → page 8

HALFEN HTA ANCHOR CHANNELS

Materials / Corrosion Protection

Corrosion Protection

To ensure that connections perform to their full potential throughout their service life it is critical that the correct corrosion protection is chosen.

The corrosion process is complex and can be attributed to many factors. HALFEN Anchor Channels are available in either hot-dip galvanized ($\geq 50 \mu\text{m}$) or stainless steel depending on the level of corrosion resistance required.

The corrosion resistance of zinc coatings is primarily dependent on the thickness of the coating relative to the environmental conditions.

Zinc corrosion rates can be obtained from the American Galvanizers Association and ASTM B 633. A table of mean corrosion rates for various environments is provided to the right. It should be noted that these values are for general reference only and are provided only to give a better estimate of the expected service life of the zinc coating. Stainless steel is recommended for moderately to highly corrosive environments (industrial and coastal environments) or where an extended lifetime of the connection is warranted.

Atmosphere	Mean Corrosion Rate
Industrial	5.6 $\mu\text{m}/\text{year}$
Urban non-industrial	1.5 $\mu\text{m}/\text{year}$
Marine	1.5 $\mu\text{m}/\text{year}$
Suburban	1.3 $\mu\text{m}/\text{year}$
Rural	0.8 $\mu\text{m}/\text{year}$
Indoors	< 0.5 $\mu\text{m}/\text{year}$

- Table obtained from ASTM B 633 Appendix X1.
- The mean corrosion rates apply only to zinc and do not include a corrosion rate when zinc is passivated or in contact with other materials.
- All components are hot-dip galvanized in accordance with ASTM A153

Contact Corrosion

Dissimilar metals and alloys have different electrode potentials. Corrosion can occur between dissimilar metals or alloys when they come in contact and are in the presence of an electrolyte (e.g. water). The electro potential between the dissimilar metals is the cause of an accelerated corrosion

of the anode member of the galvanic couple. This type of corrosion is referred to as Galvanic Corrosion or Bi-metal Corrosion.

Interior connections located in dry environments are typically not susceptible to this type of corrosion.

To prevent Galvanic Corrosion from occurring all T-bolts, nuts, washers and channels are recommended to be of the same material, i.e. stainless steel bolts, nuts and washers shall be used with stainless steel channels.

Corrosion Protection Requirements

HALFEN HTA 72/48 Stainless Steel Anchor Channels utilize mill finished carbon steel I-anchors welded on the back of the profile.

The corrosion protection of the anchors is guaranteed due to a concrete cover of $c = a + b = 2\frac{5}{16}"$ (60 mm) as illustrated.

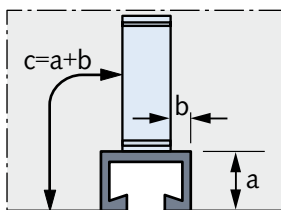

Concrete cover c

The minimum concrete cover is based on local environmental conditions and bid specifications.

HALFEN HTA stainless steel Anchor Channels are delivered with stainless steel, bolted round anchors.

The corrosive resistance of these anchors is not restricted to any minimum concrete cover due to the higher corrosion protection of the material used.

Areas of application

- Bridge and tunnel construction (fastening of pipes, etc.)
- Construction of sewage treatment plants (fixing of spillovers)
- Chemical industry (installations exposed to aggressive substances)
- Ventilated façades, e.g. masonry renders

HALFEN HTA ANCHOR CHANNELS

General Information

Calculation Method according to AC 232

The capacity of HALFEN HTA Anchor Channels is calculated according to ICC-ESR 1008 Evaluation Report by the International Code Council Evaluation Service (ICC-ES). The Evaluation Report refers to the Acceptance Criteria for Anchor Channels in Concrete Elements AC232 by ICC-ES. The design requirements are primarily based on the principles presented in ACI 318-14, chapter 17 (previously ACI 318-11, Appendix D) with amendments as applicable to the strength design of anchor channels. Following standard Strength Design (LRFD) principles, it is required that the following strength requirements be verified:

Bolts and Channel Lips

$$\phi N_{ssr}, \phi N_{sl} \geq N_{ua}^b$$

$$\phi V_{ssr}, \phi V_{sl,y} \geq V_{ua}^b$$

Channel, Anchors and Concrete

$$\phi N_{ncr}, \phi N_{ns,a} \geq N_{ua}^a$$

$$\phi V_{ncr}, \phi V_{ns,a} \geq V_{ua}^a$$

Channel Flexure

$$\phi M_{s,flex} \geq M_{u,flex}$$

N_{ua}^b and V_{ua}^b are the loads acting on the T-bolt(s).

N_{ua}^a and V_{ua}^a are the loads acting on the anchors. These loads are determined using the factored tension and shear loads calculated in accordance with ACI 318-14 Sec. 5.3 or ASCE 7-10 Sec. 2.3.

$M_{u,flex}$ is the bending moment on the channel due to the factored tension load(s) N_{ua}^b .

N_{nc} and V_{nc} are the nominal tension and shear capacities of one anchor from all concrete failure modes outlined in the table to the right.

$N_{ns,a}$ and $V_{ns,a}$ are the minimum tension and shear capacities for steel failure of an anchor or connection between anchor and channel ($N_{sar}, N_{scr}, V_{sa,yr}, V_{sc,yr}$).

All relevant strength reduction factors ϕ are provided in the table to the right. If the load combinations referenced in ACI 318-11 Appendix C are used, the appropriate strength reduction factor should be used in accordance with AC232.

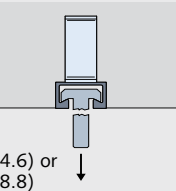
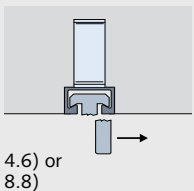
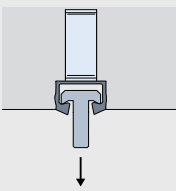
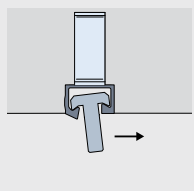
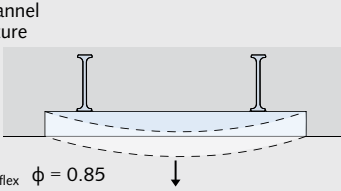
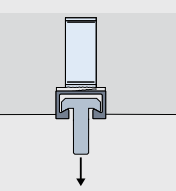
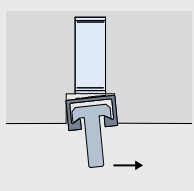
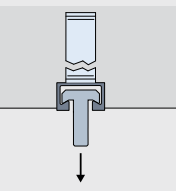
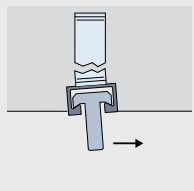
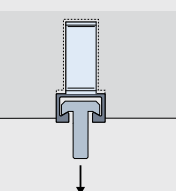
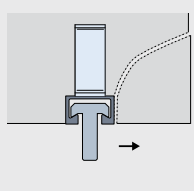
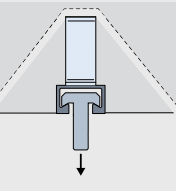
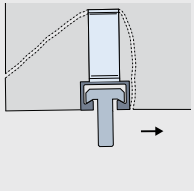
	Tension loading (N)		Loading in shear (V)	
Steel failure modes	T-bolt		T-bolt	
	N_{ss}		V_{ss}	
		$\phi = 0.75$ (Grade 4.6) or 0.65 (Grade 8.8)		$\phi = 0.65$ (Grade 4.6) or 0.60 (Grade 8.8)
	Local flexure of channel lip		Local flexure of channel lip	
	N_{sl}		$V_{sl,y}$	
		$\phi = 0.75$		$\phi = 0.75$
Channel flexure				
	$M_{s,flex} \phi = 0.85$			
Connection between anchor and channel			Connection between anchor and channel	
N_{sc}		$V_{sc,y}$		
	$\phi = 0.75$		$\phi = 0.75$	
Anchor			Anchor	
N_{sa}		$V_{sa,y}$		
	$\phi = 0.75$		$\phi = 0.75$	
Concrete failure modes	Pull-out failure		Concrete edge failure	
	N_{pn}		$V_{cb,y}$	
		$\phi = 0.70$		$\phi = 0.70$
Concrete cone failure			Concrete pry-out failure	
N_{cb}		$V_{cp,y}$		
	$\phi = 0.70$		$\phi = 0.70$	

HALFEN HTA ANCHOR CHANNELS

Product Overview

HALFEN HTA Anchor Channels — Product Overview				
HALFEN HTA Anchor Channel	HTA 72/48	HTA 55/42	HTA 52/34	
Material ①	HDG			
	A4			
Type	hot rolled	hot rolled	hot rolled	
Page	11	12	13	
HALFEN HS T-bolt available diameters	HS 72/48 M20 to M30 (≈3/4" to ≈1 1/4")	HS 50/30 M10 to M24 (≈3/8" to ≈1")	HS 50/30 M10 to M20 (≈3/8" to ≈3/4")	
Page	20	21	21	
HALFEN HTA Anchor Channel	HTA 50/30	HTA 40/22	HTA 38/17	HTA 28/15
Material ①	HDG			
	A4			
Type	hot rolled	hot rolled	cold formed	cold formed
Page	14	15	16	17
HALFEN HS T-bolt available diameters	HS 50/30 M10 to M20 (≈3/8" to ≈3/4")	HS 40/22 M10 to M16 (≈3/8" to ≈5/8")	HS 38/17 M10 to M16 (≈3/8" to ≈5/8")	HS 28/15 M6 to M12 (≈1/4" to ≈1/2")
Page	21	22	23	24
① HDG = Hot-dip galvanized carbon steel / A4 = Stainless steel				

HALFEN HTA ANCHOR CHANNELS

Load Capacities and Ordering Information

HALFEN HTA 72/48 Anchor Channels, hot rolled

HTA 72/48							
b _{ch}	2 13/16" [72 mm]						
h _{ch}	1 15/16" [48.5 mm]						
h _t	5/8" [15.5 mm]						
h _{ef}	7 1/16" [179 mm]						
c _{a,min}	5 7/8" [150 mm]						
Material	Hot-dip galvanized carbon steel ^①			Stainless steel A4 ^②			
T-bolt size /available thread	HS 72/48 / M20, M24, M27, and M30						
N _{sl}	26,975 lbf	[120.0 kN]		22,481 lbf	[100.0 kN]		
V _{sl}	26,975 lbf	[120.0 kN]		22,481 lbf	[100.0 kN]		
M _{s,flex}	77,725 lbf-in	[8,782 Nm]		77,725 lbf-in	[8,782 Nm]		
I _y	0.8402 in ⁴	[349,721 mm ⁴]		0.8402 in ⁴	[349,721 mm ⁴]		
N _{ns,a} = min [N _{sc} , N _{sa}]	24,280 lbf	[108.0 kN]		22,481 lbf	[100.0 kN]		
V _{ns,a} = min [V _{sc,y} , V _{sa,y}]	26,975 lbf	[120.0 kN]		22,481 lbf	[100.0 kN]		
Available lengths	Article number	Description	Number of anchors	Article number	Description	Number of anchors	
6" [150 mm]	0001.120-00503	HTA 72/48-HDG-150	2	2001.122-00801	HTA 72/48-A4-150	2	
8" [200 mm]	0001.120-00504	HTA 72/48-HDG-200	2	2001.122-00802	HTA 72/48-A4-200	2	
10" [250 mm]	0001.120-00505	HTA 72/48-HDG-250	2	2001.122-00803	HTA 72/48-A4-250	2	
12" [300 mm]	0001.120-00506	HTA 72/48-HDG-300	2	2001.122-00804	HTA 72/48-A4-300	2	
14" [350 mm]	0001.120-00507	HTA 72/48-HDG-350	2	2001.122-00805	HTA 72/48-A4-350	3	
16" [400 mm]	0001.120-00508	HTA 72/48-HDG-400	3	2001.122-00806	HTA 72/48-A4-400	3	
21 1/2" [550 mm]	0001.120-00509	HTA 72/48-HDG-550	3	2001.122-00807	HTA 72/48-A4-550	3	
31 1/2" [800 mm]	0001.120-00510	HTA 72/48-HDG-800	4	-	-	-	
3'-5" [1,050 mm]	0001.120-00511	HTA 72/48-HDG-1050	5	2001.122-00808	HTA 72/48-A4-1050	5	
9'-11" [3,030 mm]	0001.120-00512	HTA 72/48-HDG-3030	11	-	-	-	
19'-11" [6,070 mm]	0001.120-00501	HTA 72/48-HDG-6070	21	2001.122-00008	HTA 72/48-A4-6070	25	
^① Welded I-Anchor in HDG finish is included in ICC-ESR 1008 ^② Stainless steel (A4) channel profile with welded carbon steel I-anchor (see page 8 for information on corrosion protection)							

HALFEN HTA ANCHOR CHANNELS

Load Capacities and Ordering Information

HALFEN HTA 55/42 Anchor Channels, hot rolled

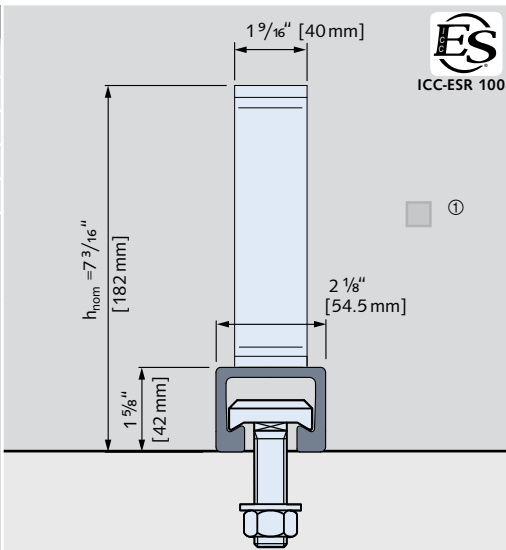
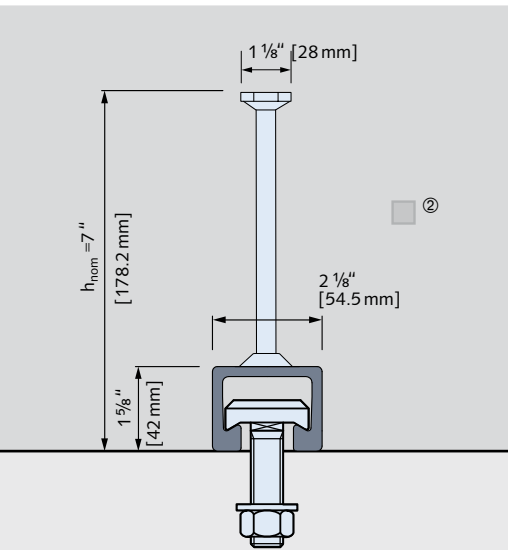
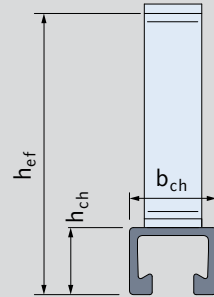
HTA 55/42							
b _{ch}	2 1/8" [54.5 mm]	Hot-dip galvanized carbon steel ^①			Hot-dip galvanized carbon steel ^②		
h _{ch}	1 5/8" [42 mm]	HS 50/30 / M10, M12, M16, M20, and M24					
h _t	1/2" [12.9 mm]	21,355 lbf [95.0 kN]			17,985 lbf [80.0 kN]		
h _{ef}	6 7/8" [175 mm]	22,480 lbf [100.0 kN]			22,480 lbf [100.0 kN]		
C _{a,min}	3 15/16" [100 mm]	54,260 lbf-in [6,131 Nm]			54,260 lbf-in [6,131 Nm]		
		0.4504 in ⁴ [187,464 mm ⁴]			0.4504 in ⁴ [187,464 mm ⁴]		
Material		N _{ns,a} = min [N _{sc} , N _{sa}]			17,985 lbf [80.0 kN]		
T-bolt size /available thread		V _{ns,a} = min [V _{sc,y} , V _{sa,y}]			22,480 lbf [100.0 kN]		
N _{sl}		Available lengths			Article number		
V _{sl,y}		Description			Number of anchors		
M _{s,flex}		Article ① number			Description		
I _y		Article ② number			Description		
N _{ns,a} = min [N _{sc} , N _{sa}]		Description			Number of anchors		
V _{ns,a} = min [V _{sc,y} , V _{sa,y}]		Description			Number of anchors		
Available lengths		Description			Number of anchors		
6" [150 mm]		HTA 55/42-HDG-150			2		
8" [200 mm]		HTA 55/42-HDG-200			2		
10" [250 mm]		HTA 55/42-HDG-250			2		
12" [300 mm]		HTA 55/42-HDG-300			2		
14" [350 mm]		HTA 55/42-HDG-350			2		
16" [400 mm]		HTA 55/42-HDG-400			3		
21 1/2" [550 mm]		HTA 55/42-HDG-550			3		
31 1/2" [800 mm]		HTA 55/42-HDG-800			4		
3'-5" [1,050 mm]		HTA 55/42-HDG-1050			5		
9'-11" [3,030 mm]		HTA 55/42-HDG-3030			11		
19'-11" [6,070 mm]		HTA 55/42-HDG-6070			21		

① Welded I-Anchor in HDG finish is included in ICC-ESR 1008
 ② Bolted anchor version available in hot-dip galvanized carbon steel on request

HALFEN HTA ANCHOR CHANNELS

Load Capacities and Ordering Information

HALFEN HTA 52/34 Anchor Channels, hot rolled

HTA 52/34							
b_{ch}	2 1/16" [52.5 mm]						
h_{ch}	1 5/16" [33.5 mm]						
h_t	7/16" [10.5 mm]						
h_{ef}	6 1/8" [155 mm]						
$c_{a,min}$	3 15/16" [100 mm]						
Material		Hot-dip galvanized carbon steel ^①			Stainless steel A4		
T-bolt size /available thread		HS 50/30 / M10, M12, M16, and M20					
N_{sl}		14,615 lbf	[65.0 kN]		14,615 lbf	[65.0 kN]	
$V_{sl,y}$		15,735 lbf	[70.0 kN]		15,735 lbf	[70.0 kN]	
$M_{s,flex}$		32,550 lbf-in	[3,678 Nm]		32,550 lbf-in	[3,678 Nm]	
I_y		0.2241 in ⁴	[93,262 mm ⁴]		0.2441 in ⁴	[93,262 mm ⁴]	
$N_{ns,a} = \min [N_{sc}, N_{sa}]$		14,615 lbf	[65.0 kN]		12,365 lbf	[55.0 kN]	
$V_{ns,a} = \min [V_{sc,y}, V_{sa,y}]$		15,735 lbf	[70.0 kN]		15,735 lbf	[70.0 kN]	
Available lengths		Article number	Description	Number of anchors	Article number	Description	Number of anchors
6" [150 mm]		0001.090-00503	HTA 52/34-HDG-150	2	2001.092-00801	HTA 52/34-A4-150-B6	2
8" [200 mm]		0001.090-00504	HTA 52/34-HDG-200	2	2001.092-00802	HTA 52/34-A4-200-B6	2
10" [250 mm]		0001.090-00505	HTA 52/34-HDG-250	2	2001.092-00803	HTA 52/34-A4-250-B6	2
12" [300 mm]		0001.090-00506	HTA 52/34-HDG-300	2	2001.092-00804	HTA 52/34-A4-300-B6	2
14" [350 mm]		0001.090-00507	HTA 52/34-HDG-350	3	2001.092-00805	HTA 52/34-A4-350-B6	3
16" [400 mm]		0001.090-00508	HTA 52/34-HDG-400	3	2001.092-00806	HTA 52/34-A4-400-B6	3
21 1/2" [550 mm]		0001.090-00510	HTA 52/34-HDG-550	3	2001.092-00807	HTA 52/34-A4-550-B6	3
31 1/2" [800 mm]		0001.090-00513	HTA 52/34-HDG-800	4	2001.092-00808	HTA 52/34-A4-800-B6	4
3'-5" [1,050 mm]		0001.090-00516	HTA 52/34-HDG-1050	5	2001.092-00809	HTA 52/34-A4-1050-B6	5
9'-11" [3,030 mm]		0001.090-00517	HTA 52/34-HDG-3030	13	-	-	-
19'-11" [6,070 mm]		0001.090-00501	HTA 52/34-HDG-6070	25	2001.092-00008	HTA 52/34-A4-6070-B6	25
① Welded I-Anchor in HDG finish is included in ICC-ESR 1008 ② Bolted Anchor version available in hot-dip galvanized on request							

HALFEN HTA ANCHOR CHANNELS

Load Capacities and Ordering Information

HALFEN HTA 50/30 Anchor Channels, hot rolled

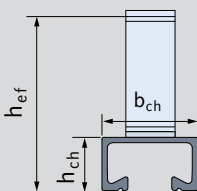
HTA 50/30							
b _{ch}	1 15/16" [49 mm]						
h _{ch}	1 3/16" [30 mm]						
h _t	5/16" [7.85 mm]						
h _{ef}	3 3/4" [96 mm]						
c _{a,min}	2 15/16" [75 mm]						
Material		Hot-dip galvanized carbon steel ^①			Stainless steel A4		
T-bolt size /available thread		HS 50/30 / M10, M12, M16, and M20					
N _{sl}		8,770 lbf [39.0 kN]			8,093 lbf [36.0 kN]		
V _{sl,y}		10,115 lbf [45.0 kN]			9,060 lbf [40.3 kN]		
M _{s,flex}		19,835 lbf-in [2,241 Nm]			18,418 lbf-in [2,081 Nm]		
I _y		0.1263 in ⁴ [52,575 mm ⁴]			0.1247 in ⁴ [52,575 mm ⁴]		
N _{ns,a} = min [N _{sc} , N _{sa}]		8,770 lbf [39.0 kN]			6,969 lbf [31.0 kN]		
V _{ns,a} = min [V _{sc,y} , V _{sa,y}]		10,115 lbf [45.0 kN]			9,060 lbf [40.3 kN]		
Available lengths		Article number	Description	Number of anchors	Article number	Description	Number of anchors
6"	[150 mm]	0001.080-00503	HTA 50/30-HDG-150	2	2001.082-00801	HTA 50/30-A4-150-B6	2
8"	[200 mm]	0001.080-00504	HTA 50/30-HDG-200	2	2001.082-00802	HTA 50/30-A4-200 -B6	2
10"	[250 mm]	0001.080-00505	HTA 50/30-HDG-250	2	2001.082-00803	HTA 50/30-A4-250 -B6	2
12"	[300 mm]	0001.080-00506	HTA 50/30-HDG-300	2	2001.082-00804	HTA 50/30-A4-300 -B6	2
14"	[350 mm]	0001.080-00507	HTA 50/30-HDG-350	3	2001.082-00805	HTA 50/30-A4-350 -B6	3
16"	[400 mm]	0001.080-00508	HTA 50/30-HDG-400	3	2001.082-00806	HTA 50/30-A4-400 -B6	3
21 1/2"	[550 mm]	0001.080-00510	HTA 50/30-HDG-550	3	2001.082-00807	HTA 50/30-A4-550 -B6	3
31 1/2"	[800 mm]	0001.080-00513	HTA 50/30-HDG-800	4	2001.082-00808	HTA 50/30-A4-800 -B6	4
3'-5"	[1,050 mm]	0001.080-00516	HTA 50/30-HDG-1050	5	2001.082-00809	HTA 50/30-A4-1050 -B6	5
9'-11"	[3,030 mm]	0001.080-00517	HTA 50/30-HDG-3030	13	2001.082-00810	HTA 50/30-A4-3030 -B6	13
19'-11"	[6,070 mm]	0001.080-00501	HTA 50/30-HDG-6070	25	2001.082-00008	HTA 50/30-A4-6070 -B6	25
^① Welded I-Anchor in HDG finish is included in ICC-ESR 1008 ^② Bolted Anchor version available in hot-dip galvanized on request							

HALFEN HTA ANCHOR CHANNELS

Load Capacities and Ordering Information

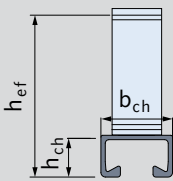
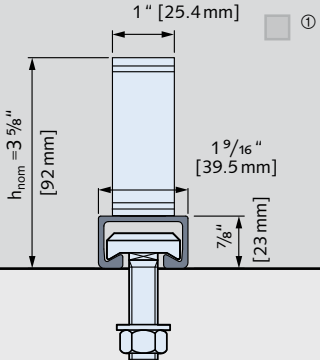
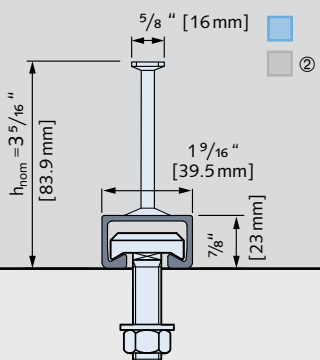

HALFEN HTA 40/22 Anchor Channels, hot rolled

HTA 40/22		 ICC-ESR 1008								
b_{ch}	1 3/16" [39.5 mm]									
h_{ch}	7/8" [23 mm]									
h_t	1/4" [6 mm]									
h_{ef}	3 1/2" [89 mm]									
$c_{a,min}$	1 15/16" [50 mm]									
Material		Hot-dip galvanized carbon steel ^①			Stainless steel A4					
T-bolt size /available thread		HS 40/22 / M10, M12 and M16								
N_{sl}		6,745 lbf [30.0 kN]			6,745 lbf [30.0 kN]					
$V_{sl,y}$		6,745 lbf [30.0 kN]			5,845 lbf [26.0 kN]					
$M_{s,flex}$		12,190 lbf-in [1,377 Nm]			9,523 lbf-in [1,080 Nm]					
I_y		0.0477 in ⁴ [19,859 mm ⁴]			0.0477 in ⁴ [19,859 mm ⁴]					
$N_{ns,a} = \min [N_{sc}, N_{sa}]$		6,745 lbf [30.0 kN]			4,496 lbf [20.0 kN]					
$V_{ns,a} = \min [V_{sc,y}, V_{sa,y}]$		6,745 lbf [30.0 kN]			6,745 lbf [30.0 kN]					
Available lengths		Article number	Description	Number of anchors	Article number	Description	Number of anchors			
6"	[150 mm]	0001.040-00503	HTA 40/22-HDG-150	2	2001.042-00801	HTA 40/22-A4-150-B6	2			
8"	[200 mm]	0001.040-00504	HTA 40/22-HDG-200	2	2001.042-00802	HTA 40/22-A4-200-B6	2			
10"	[250 mm]	0001.040-00505	HTA 40/22-HDG-250	2	2001.042-00803	HTA 40/22-A4-250-B6	2			
12"	[300 mm]	0001.040-00506	HTA 40/22-HDG-300	2	2001.042-00804	HTA 40/22-A4-300-B6	2			
14"	[350 mm]	0001.040-00507	HTA 40/22-HDG-350	3	2001.042-00805	HTA 40/22-A4-350-B6	3			
16"	[400 mm]	0001.040-00508	HTA 40/22-HDG-400	3	2001.042-00806	HTA 40/22-A4-400-B6	3			
21 1/2"	[550 mm]	0001.040-00510	HTA 40/22-HDG-550	3	2001.042-00807	HTA 40/22-A4-550-B6	3			
31 1/2"	[800 mm]	0001.040-00513	HTA 40/22-HDG-800	4	-	-	-			
3'-5"	[1,050 mm]	0001.040-00516	HTA 40/22-HDG-1050	5	2001.042-00808	HTA 40/22-A4-1050-B6	5			
9'-11"	[3,030 mm]	0001.040-00517	HTA 40/22-HDG-3030	13	-	-	-			
19'-11"	[6,070 mm]	0001.040-00501	HTA 40/22-HDG-6070	25	2001.042-00008	HTA 40/22-A4-6070-B6	25			
① Welded I-Anchor in HDG finish is included in ICC-ESR 1008 ② Bolted Anchor version available in hot-dip galvanized on request										

HALFEN HTA ANCHOR CHANNELS

Load Capacities and Ordering Information

HALFEN HTA 38/17 Anchor Channels, cold formed

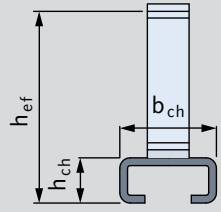
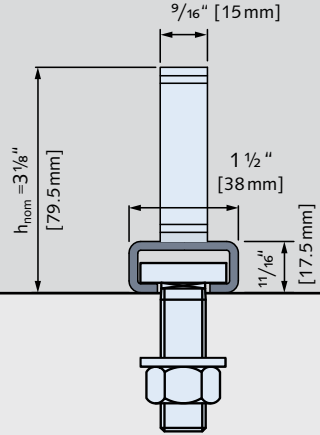
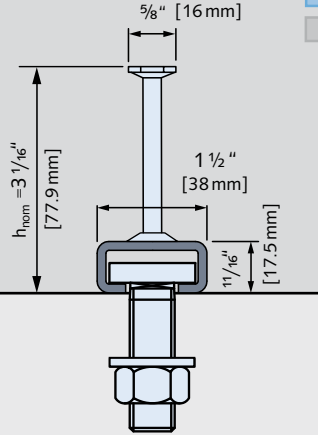
HTA 38/17										
b_{ch}	1 1/2" [38 mm]									
h_{ch}	1 1/16" [17.5 mm]									
h_t	1/8" [3 mm]									
h_{ef}	3" [76 mm]									
$c_{a,min}$	1 15/16" [50 mm]									
Material		Hot-dip galvanized carbon steel ^①			Stainless steel A4 ^③					
T-bolt size /available thread		HS 38/17 / M10, M12, and M16								
N_{sl}		4,045 lbf	[18.0 kN]		4,045 lbf	[18.0 kN]				
$V_{sl,y}$		4,045 lbf	[18.0 kN]		4,045 lbf	[18.0 kN]				
$M_{s,flex}$		5,135 lbf-in	[580 Nm]		5,250 lbf-in	[593 Nm]				
I_y		0.0205 in ⁴	[8,547 mm ⁴]		0.0205 in ⁴	[8,547 mm ⁴]				
$N_{ns,a} = \min [N_{sc}, N_{sa}]$		4,045 lbf	[18.0 kN]		4,045 lbf	[18.0 kN]				
$V_{ns,a} = \min [V_{sc,y}, V_{sa,y}]$		4,045 lbf	[18.0 kN]		4,045 lbf	[18.0 kN]				
Available lengths		Article number	Description	Number of anchors	Article number	Description	Number of anchors			
4" [100 mm]		0001.020-00502	HTA 38/17-HDG-100	2	2001.022-08001	HTA 38/17-A4-100-B6	2			
6" [150 mm]		0001.020-00503	HTA 38/17-HDG-150	2	2001.022-08002	HTA 38/17-A4-150-B6	2			
8" [200 mm]		0001.020-00504	HTA 38/17-HDG-200	2	2001.022-08003	HTA 38/17-A4-200-B6	2			
10" [250 mm]		0001.020-00505	HTA 38/17-HDG-250	2	2001.022-08004	HTA 38/17-A4-250-B6	2			
12" [300 mm]		0001.020-00506	HTA 38/17-HDG-300	3	2001.022-08005	HTA 38/17-A4-300-B6	3			
14" [350 mm]		0001.020-00507	HTA 38/17-HDG-350	3	2001.022-08006	HTA 38/17-A4-350-B6	3			
17 1/2" [450 mm]		0001.020-00509	HTA 38/17-HDG-450	3	2001.022-08007	HTA 38/17-A4-450-B6	3			
21 1/2" [550 mm]		0001.020-00510	HTA 38/17-HDG-550	4	2001.022-08008	HTA 38/17-A4-550-B6	4			
31 1/2" [850 mm]		0001.020-00514	HTA 38/17-HDG-850	5	2001.022-08009	HTA 38/17-A4-850-B6	5			
3'-5" [1,050 mm]		0001.020-00516	HTA 38/17-HDG-1050	6	2001.022-08010	HTA 38/17-A4-1050-B6	6			
9'-11" [3,030 mm]		0001.020-00517	HTA 38/17-HDG-3030	16	2001.022-08011	HTA 38/17-A4-3030-B6	16			
19'-10" [6,070 mm]		0001.020-00501	HTA 38/17-HDG-6070	31	2001.022-00006	HTA 38/17-A4-6070-B6	31			
① Welded I-Anchor in HDG finish is included in ICC-ESR 1008 ② Bolted Anchor version available in hot-dip galvanized on request ③ Bolted Anchor in HDG finish and stainless steel A4 is included in ICC-ESR 1008										

HALFEN HTA ANCHOR CHANNELS

Load Capacities and Ordering Information

HALFEN HTA 28/15 Anchor Channels, cold formed

HTA 28/15		Hot-dip galvanized carbon steel ^①			Stainless steel A4 ^③		
b_{ch}	1 1/8" [28 mm]						
h_{ch}	5/8" [15.25 mm]						
h_t	1/16" [2.25 mm]						
h_{ef}	1 3/4" [45 mm]						
$C_{a,min}$	1 9/16" [40 mm]						
Material	Hot-dip galvanized carbon steel ^①			Stainless steel A4 ^③			
T-bolt size /available thread	HS 28/15 / M6, M8, M10, and M12						
N_{sl}	2,025 lbf	[9.0 kN]	2,025 lbf			[9.0 kN]	
$V_{sl,y}$	2,025 lbf	[9.0 kN]	2,025 lbf			[9.0 kN]	
$M_{s,flex}$	2,745 lbf-in	[310 Nm]	2,830 lbf-in			[320 Nm]	
I_y	0.0098 in ⁴	[4,060 mm ⁴]	0.0098 in ⁴			[4,060 mm ⁴]	
$N_{ns,a} = \min [N_{sc}, N_{sa}]$	2,025 lbf	[9.0 kN]	2,025 lbf			[9.0 kN]	
$V_{ns,a} = \min [V_{sc,y}, V_{sa,y}]$	2,025 lbf	[9.0 kN]	2,025 lbf			[9.0 kN]	
Available lengths	Article number	Description	Number of anchors	Article number	Description	Number of anchors	
4" [100 mm]	0001.010-00502	HTA 28/15-HDG-100	2	2001.012-08001	HTA 28/15-A4-100-B6	2	
6" [150 mm]	0001.010-00503	HTA 28/15-HDG-150	2	2001.012-08002	HTA 28/15-A4-150-B6	2	
8" [200 mm]	0001.010-00504	HTA 28/15-HDG-200	2	2001.012-08003	HTA 28/15-A4-200-B6	2	
10" [250 mm]	0001.010-00505	HTA 28/15-HDG-250	2	2001.012-08004	HTA 28/15-A4-250-B6	2	
12" [300 mm]	0001.010-00506	HTA 28/15-HDG-300	3	2001.012-08005	HTA 28/15-A4-300-B6	3	
14" [350 mm]	0001.010-00507	HTA 28/15-HDG-350	3	2001.012-08006	HTA 28/15-A4-350-B6	3	
17 1/2" [450 mm]	0001.010-00509	HTA 28/15-HDG-450	3	2001.012-08007	HTA 28/15-A4-450-B6	3	
21 1/2" [550 mm]	0001.010-00510	HTA 28/15-HDG-550	4	2001.012-08008	HTA 28/15-A4-550-B6	4	
33 1/2" [850 mm]	0001.010-00514	HTA 28/15-HDG-850	5	2001.012-08009	HTA 28/15-A4-850-B6	5	
3'-5" [1,050 mm]	0001.010-00516	HTA 28/15-HDG-1050	6	2001.012-08010	HTA 28/15-A4-1050-B6	6	
9'-11" [3,030 mm]	0001.010-00517	HTA 28/15-HDG-3030	16	2001.012-08011	HTA 28/15-A4-3030-B6	16	
19'-11" [6,070 mm]	0001.010-00501	HTA 28/15-HDG-6070	31	2001.012-00006	HTA 28/15-A4-6070-B6	31	
① Welded I-Anchor in HDG finish is included in ICC-ESR 1008 ② Bolted Anchor version available in hot-dip galvanized on request ③ Bolted Anchor in HDG finish and stainless steel A4 is included in ICC-ESR 1008							

HALFEN HTA ANCHOR CHANNELS

HALFEN HS T-bolts

Supplementary Reinforcement according to AC 232

For conditions where the factored tensile and shear force exceed the concrete breakout strength of the HALFEN Anchor Channel or where the breakout strength is not evaluated, it is permitted within AC232 that the nominal strength can be that of anchor reinforcement properly placed as shown in the figures to the right.

Anchor reinforcement should consist of stirrups, ties or hairpins comprised of formed reinforcing bars with a maximum diameter of $\frac{5}{8}$ inch (15.5 mm). Rebars shall be placed as close as possible to the anchor and anchor channel. The anchor reinforcement shall be developed in accordance with the latest edition of ACI 318 on both sides of the breakout surface of an anchor or anchor channel.

Shear Anchor Reinforcement

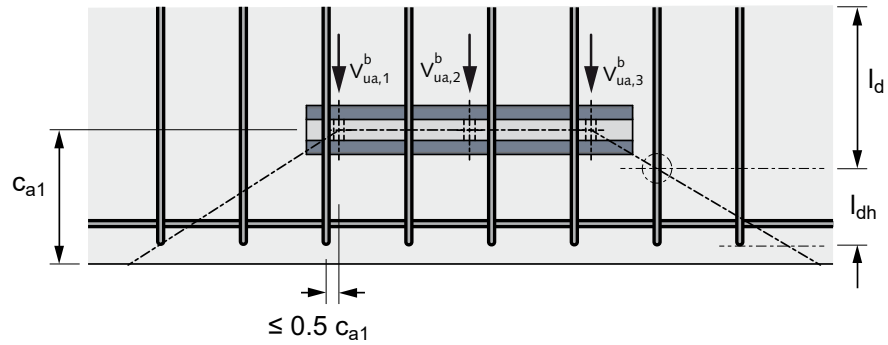

Tensile Anchor Reinforcement

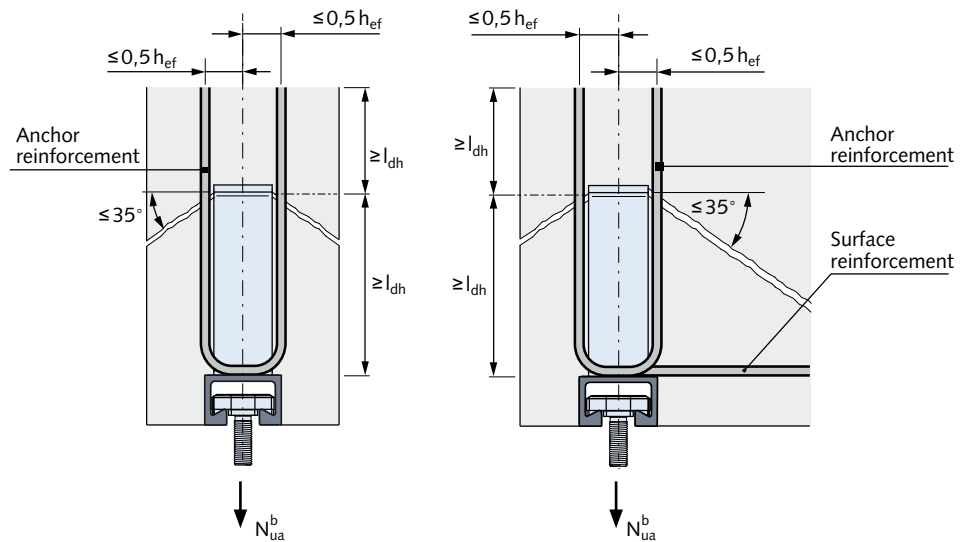

l_d = Development length in tension of deformed rebar

l_{dh} = Development length in tension of deformed rebar with a standard hook

c_{a1} = Edge distance of anchor channel

HALFEN HTA ANCHOR CHANNELS

HALFEN HS T-bolts

Product Overview

HALFEN HTA Anchor Channels and HS T-bolts are designed to work as a system. The loads provided in the Evaluation Report are only valid when the appropriate HS T-bolt is used in conjunction with the appropriate HTA Anchor Channel profile. HALFEN HS T-bolts are available in carbon steel strength class 4.6 or 8.8 and in stainless steel strength class A4-50 and A4-70.

Carbon steel T-bolts are available in two finishes; hot-dipped galvanized (HDG) or special electro-plated coating (EP) with thick layer passivation.

HALFEN HS T-bolts are available in a wide range of diameters and lengths. The following pages show a selection of our available HS T-bolts sorted by T-bolt type.

For more HALFEN HS T-bolts please refer to the HALFEN Price book or contact your local Sales Representative.



Ordering example HALFEN HS T-bolts:

HALFEN HS	50/30	M16	x 60	EP	
HALFEN HS	38/17	M10	x 60	A4	- 70

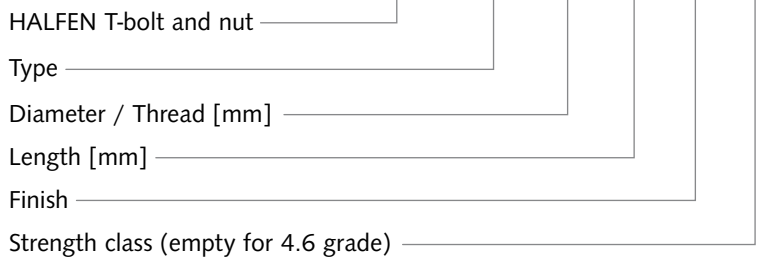

HALFEN T-bolts can be ordered by referencing the corresponding article description (see left) or the 12 digit article number (see tables on pages 20 to 24).

Required T-bolt Length

$$l_{req} = t_{fix} + h_t + h + v_{min}$$

- l_{req} = Required T-bolt length
- t_{fix} = Thickness of clamped component
- h_t = Channel lip height
- h = Washer thickness

An additional overhang of $\frac{3}{16}$ " [5 mm] should be considered for M6 to M16 diameters and $\frac{1}{4}$ " [7mm] for diameters greater than or equal to M20. The overhang is included in the listed values of v_{min} .

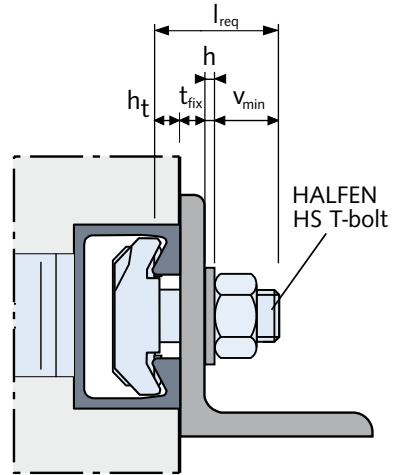

Dimension		
T-bolt size	v_{min}	
	inch	mm
M6	$\frac{7}{16}$	11.0
M8	$\frac{1}{2}$	12.5
M10	$\frac{9}{16}$	14.5
M12	$1\frac{1}{16}$	17.0
M16	$1\frac{3}{16}$	20.5
M20	1	26.0
M24	$1\frac{1}{8}$	29.0
M27	$1\frac{1}{4}$	31.5
M30	$1\frac{5}{16}$	33.5

Channel lip height		
Channel profile	h_t	
	inch	mm
28/15	$\frac{1}{16}$	2.25
38/17	$\frac{1}{8}$	3.0
40/22	$\frac{1}{4}$	6.0
50/30	$\frac{5}{16}$	7.85
52/34	$\frac{7}{16}$	10.5
55/42	$\frac{1}{2}$	12.9
72/48	$\frac{5}{8}$	15.5

HALFEN HTA ANCHOR CHANNELS

HALFEN HS 72/48 T-bolts

Load Resistance Values



The tables on the following pages show the nominal strength for HALFEN HS T-bolts.

N_{ss} is the nominal tensile strength, V_{ss} the nominal shear strength and M_{ss}^0 is the nominal bending strength for T-bolts where a shear force is applied with a lever arm.

Strength reduction factors for steel failure specified in ESR 1008 are provided in the table below.

Refer to page 18 for information on ordering HALFEN HS T-bolts.

Nominal strength values												
T-bolt size	Material / Grade											
	4.6			8.8			A4-50			A4-70		
	N_{ss}	V_{ss}	M_{ss}^0	N_{ss}	V_{ss}	M_{ss}^0	N_{ss}	V_{ss}	M_{ss}^0	N_{ss}	V_{ss}	M_{ss}^0
	lbf [kN]	lbf [kN]	lbf-in [Nm]	lbf [kN]	lbf [kN]	lbf-in [Nm]	lbf [kN]	lbf [kN]	lbf-in [Nm]	lbf [kN]	lbf [kN]	lbf-in [Nm]
M20	22,031 [98.0]	13,220 [58.8]	2,300 [259.6]	44,063 [196.0]	26,440 [117.6]	4,600 [519.3]	-	-	-	-	-	-
M24	31,743 [141.2]	19,040 [84.7]	3,975 [449.0]	63,486 [282.4]	38,085 [169.4]	7,945 [898.0]	39,680 [176.5]	23,805 [105.9]	4,965 [561.3]	-	-	-
M27	41,275 [183.6]	24,775 [110.2]	5,890 [665.8]	82,550 [367.2]	49,525 [220.3]	11,785 [1,331.5]	-	-	-	-	-	-
M30	50,447 [224.4]	30,260 [134.6]	7,960 [899.6]	-	-	-	-	-	-	-	-	-
Strength reduction factors ϕ												
	0.75	0.65	0.65	0.65	0.60	0.60	0.75	0.65	0.65	0.65	0.60	0.60

HALFEN HS 72/48 T-bolts – Selection of available T-bolts ①

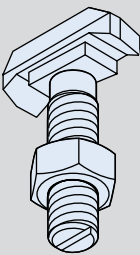
	Length inch [mm]	Thread			
		M20 (3/4")	M24 (1 1/16")	M27 (1 1/16")	M30 (1 3/16")
		HS 72/48 ...			
	1 1/16" [50]	... M20 x 50 HDG 4.6 0350.100-00003	... M24 x 50 HDG 4.6 0350.100-00008 ... M24 x 50 A4-50 0350.100-00001	-	-
	2 1/16" [75]	... M20 x 75 HDG 4.6 0350.100-00004 ... M20 x 75 EP 8.8 0350.100-00023	... M24 x 75 HDG 4.6 0350.100-00009 ... M24 x 75 HDG 8.8 0350.100-00014	... M27 x 75 HDG 4.6 0350.100-00015	... M30 x 75 HDG 4.6 0350.100-00018
	3 1/16" [100]	... M20 x 100 HDG 4.6 0350.100-00005	... M24 x 100 HDG 4.6 0350.100-00010 ... M24 x 100 EP 8.8 0350.100-00025 ... M24 x 100 A4-50 0350.100-00002	... M27 x 100 HDG 4.6 0350.100-00016 ... M27 x 100 HDG 8.8 0350.100-00017	... M30 x 100 HDG 4.6 0350.100-00019
	5 7/8" [150]	... M20 x 150 HDG 4.6 0350.100-00006	... M24x 150 HDG 4.6 0350.100-00011	-	... M30 x 150 HDG 4.6 0350.100-00020
	7 7/8" [200]	... M20 x 200 HDG 4.6 0350.100-00007	... M24 x 200 HDG 4.6 0350.100-00012	-	... M30 x 200 HDG 4.6 0350.100-00021



① Non-listed T-bolt sizes available on request. Contact your local Sales Representative for more information

HALFEN HTA ANCHOR CHANNELS

HALFEN HS 50/30 T-bolts

Nominal strength values												
T-bolt size	Material / Grade											
	4.6			8.8			A4-50			A4-70		
	N _{SS}	V _{SS}	M ⁰ _{SS}	N _{SS}	V _{SS}	M ⁰ _{SS}	N _{SS}	V _{SS}	M ⁰ _{SS}	N _{SS}	V _{SS}	M ⁰ _{SS}
	lbf [kN]	lbf [kN]	lbf-in [Nm]	lbf [kN]	lbf [kN]	lbf-in [Nm]	lbf [kN]	lbf [kN]	lbf-in [Nm]	lbf [kN]	lbf [kN]	lbf-in [Nm]
M10	5,216 [23.2]	3,125 [13.9]	265 [29.9]	-	-	-	-	-	-	-	-	-
M12	7,576 [33.7]	4,540 [20.2]	464 [52.4]	15,152 [67.4]	9,105 [40.5]	927 [104.8]	-	-	-	13,264 [59.0]	7,958 [35.4]	811 [91.7]
M16	14,118 [62.8]	8,475 [37.7]	1,180 [133.2]	28,236 [125.6]	16,950 [75.4]	2,360 [266.4]	17,647 [78.5]	8,455 [37.6]	1,175 [132.9]	-	-	-
M20	22,031 [98.0]	13,220 [58.8]	2,300 [259.6]	44,063 [196.0]	26,440 [117.6]	4,600 [519.3]	-	-	-	-	-	-
M24	31,743 [141.2]	19,040 [84.7]	3,975 [449.0]	-	-	-	-	-	-	-	-	-
Strength reduction factors φ												
	0.75	0.65	0.65	0.65	0.60	0.60	0.75	0.65	0.65	0.65	0.60	0.60

HALFEN HS 50/30 T-bolts – Selection of available T-bolts ①

	Length inch [mm]	Thread				
		M10 (3/8")	M12 (1/2")	M16 (5/8")	M20 (3/4")	M24 (1 5/16")
		HS 50/30 ...				
	1 3/16" [30]	... M10 x 30 EP 4.6 0350.090-00020	... M12 x 30 EP 4.6 0350.090-00028	-	-	-
	1 9/16" [40]	... M10 x 40 EP 4.6 0350.090-00021	... M12 x 40 EP 4.6 0350.090-00029 ... M12 x 40 A4-70 0350.090-00002	... M16 x 40 HDG 4.6 0350.090-00041	-	-
	1 3/4" [45]	-	... M12 x 45 EP 8.8 0350.090-00040	-	-	-
	1 15/16" [50]	... M10 x 50 EP 4.6 0350.090-00022	-	... M16 x 50 EP 4.6 0350.090-00048 ... M16 x 50 EP 8.8 0350.090-00058	-	-
	2 3/8" [60]	-	... M12 x 60 EP 4.6 0350.090-00031 ... M12 x 60 EP 8.8 0350.090-00037	... M16 x 60 EP 4.6 0350.090-00049 ... M16 x 60 EP 8.8 0350.090-00056 ... M16 x 60 HDG 8.8 0350.090-00045 ... M16 x 60 A4-50 0350.090-00008	-	-
	2 15/16" [75]	-	-	-	... M20 x 75 EP 4.6 0350.090-00067	... M24 x 75 HDG 4.6 ② 0350.090-00089
	3 1/8" [80]	-	... M12 x 80 EP 8.8 0350.090-00077	-	-	-
	3 15/16" [100]	-	... M12 x 100 EP 4.6 0350.090-00033	-	... M20 x 100 HDG 4.6 0350.090-00062 ... M20 x 100 EP 4.6 0350.090-00068 ... M20 x 100 EP 8.8 0350.090-00081	-
	5 7/8" [150]	-	-	... M16 x 150 A4-50 0350.090-00010	... M20 x 150 EP 8.8 0350.090-00082	-
	7 7/8" [200]	-	... M12 x 200 EP 4.6 0350.090-00036	-	-	-



① M24 T-bolt is only for the HTA 55/42 Channel series.

② Non-listed T-bolt sizes available on request. Contact your local Sales Representative for more information

HALFEN HTA ANCHOR CHANNELS

HALFEN HS 40/22 T-bolts

Nominal strength values												
T-bolt size	Material / Grade											
	4.6			8.8			A4-50			A4-70		
	N _{ss}	V _{ss}	M ⁰ _{ss}	N _{ss}	V _{ss}	M ⁰ _{ss}	N _{ss}	V _{ss}	M ⁰ _{ss}	N _{ss}	V _{ss}	M ⁰ _{ss}
	lbf [kN]	lbf [kN]	lbf-in [Nm]	lbf [kN]	lbf [kN]	lbf-in [Nm]	lbf [kN]	lbf [kN]	lbf-in [Nm]	lbf [kN]	lbf [kN]	lbf-in [Nm]
M10	5,216 [23.2]	3,125 [13.9]	265 [29.9]	-	-	-	-	-	-	9,127 [40.6]	5,485 [24.4]	463 [52.3]
M12	7,576 [33.7]	4,540 [20.2]	464 [52.4]	15,152 [67.4]	9,105 [40.5]	927 [104.8]	9,532 [42.2]	5,687 [25.3]	580 [65.5]	-	-	-
M16	13,466 [59.9]	8,475 [37.7]	1,180 [133.2]	28,236 [125.6]	16,950 [75.4]	2,360 [266.4]	17,647 [78.5]	8,455 [37.6]	1,175 [132.9]	-	-	-
Strength reduction factors ϕ												
	0.75	0.65	0.65	0.65	0.60	0.60	0.75	0.65	0.65	0.65	0.60	0.60

HALFEN HS 40/22 T-bolts – Selection of available T-bolts ①

 Length inch [mm]	Thread		
	M10 (3/8")	M12 (1/2")	M16 (5/8")
	HS 40/22 ...		
1 3/16" [30]	... M10 x 30 EP 4.6 0350.070-00022 ... M10 x 30 A4-70 0350.070-00001	... M12 x 30 EP 4.6 0350.070-00032 ... M12 x 30 HDG 4.6 0350.070-00029	... M16 x 30 EP 4.6 0350.070-00051
1 1/16" [40]	... M10 x 40 EP 4.6 0350.070-00023 ... M10 x 40 A4-70 0350.070-00002	... M12 x 40 EP 4.6 0350.070-00033 ... M12 x 40 EP 8.8 0350.070-00041 ... M12 x 40 A4-50 0350.070-00005	... M16 x 40 EP 4.6 0350.070-00052 ... M16 x 40 A4-50 0350.070-00010
1 15/16" [50]	... M10 x 50 EP 4.6 0350.070-00024 ... M10 x 50 A4-70 0350.070-00003	... M12 x 50 EP 4.6 0350.070-00034 ... M12 x 50 HDG 4.6 0350.070-00030 ... M12 x 50 A4-50 0350.070-00006	... M16 x 50 EP 4.6 0350.070-00053 ... M16 x 50 HDG 4.6 0350.070-00048 ... M16 x 50 A4-50 0350.070-00011
2 3/8" [60]	... M10 x 60 EP 4.6 0350.070-00025	... M12 x 60 EP 4.6 0350.070-00035 ... M12 x 60 EP 8.8 0350.070-00042	... M16 x 60 EP 4.6 0350.070-00054 ... M16 x 60 EP 8.8 0350.070-00071 ... M16 x 60 A4-50 0350.070-00012
3 1/8" [80]	... M10 x 80 EP 4.6 0350.070-00027	... M12 x 80 EP 4.6 0350.070-00036 ... M12 x 80 EP 8.8 0350.070-00070 ... M12 x 80 A4-50 0350.070-00007	... M16 x 80 EP 4.6 0350.070-00056 ... M16 x 80 EP 8.8 0350.070-00072 ... M16 x 80 A4-50 0350.070-00013
3 15/16" [100]	... M10 x 100 EP 4.6 0350.070-00028	... M12 x 100 EP 4.6 0350.070-00037 ... M12 x 100 EP 8.8 0350.070-00047	... M16 x 100 EP 4.6 0350.070-00057 ... M16 x 100 HDG 4.6 0350.070-00049 ... M16 x 100 A4-50 0350.070-00014
5 7/8" [150]	-	... M12 x 150 EP 4.6 0350.070-00039	... M16 x 150 EP 4.6 0350.070-00059



① Non-listed T-bolt sizes available on request. Contact your local Sales Representative for more information

HALFEN HTA ANCHOR CHANNELS

HALFEN HS 38/17 T-bolts

Nominal strength values												
T-bolt size	Material / Grade											
	4.6			8.8			A4-50			A4-70		
	N _{ss}	V _{ss}	M ⁰ _{ss}	N _{ss}	V _{ss}	M ⁰ _{ss}	N _{ss}	V _{ss}	M ⁰ _{ss}	N _{ss}	V _{ss}	M ⁰ _{ss}
	lbf [kN]	lbf [kN]	lbf-in [Nm]	lbf [kN]	lbf [kN]	lbf-in [Nm]	lbf [kN]	lbf [kN]	lbf-in [Nm]	lbf [kN]	lbf [kN]	lbf-in [Nm]
M10	5,216 [23.2]	3,125 [13.9]	265 [29.9]	-	-	-	-	-	-	9,127 [40.6]	5,485 [24.4]	463 [52.3]
M12	6,160 [27.4]	4,540 [20.2]	464 [52.4]	13,129 [58.4]	9,105 [40.5]	927 [104.8]	-	-	-	9,914 [44.1]	7,960 [35.4]	812 [91.7]
M16	12,342 [54.9]	8,475 [37.7]	1,180 [133.2]	20,817 [92.6]	16,950 [75.4]	2,360 [266.4]	11,196 [49.8]	8,455 [37.6]	1,175 [132.9]	-	-	-
Strength reduction factors ϕ												
	0.75	0.65	0.65	0.65	0.60	0.60	0.75	0.65	0.65	0.65	0.60	0.60

HALFEN HS 38/17 T-bolts – Selection of available T-bolts ①

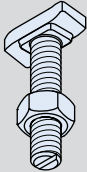
	Length inch [mm]	Thread		
		M10 (3/8")	M12 (1/2")	M16 (5/8")
		HS 38/17 ...		
	1 3/16" [30]	... M10 x 30 EP 4.6 0350.050-00038	... M12 x 30 EP 4.6 0350.050-00052 ... M12 x 30 HDG 4.6 0350.050-00046 ... M12 x 30 A4-70 0350.050-00012	... M16 x 30 EP 4.6 0350.050-00067 ... M16 x 30 HDG 4.6 0350.050-00061
	1 9/16" [40]	... M10 x 40 EP 4.6 0350.050-00039 ... M10 x 40 A4-70 0350.050-00002	... M12 x 40 EP 4.6 0350.050-00053 ... M12 x 40 A4-70 0350.050-00013	... M16 x 40 EP 4.6 0350.050-00068
	1 5/16" [50]	... M10 x 50 EP 4.6 0350.050-00040	... M12 x 50 EP 4.6 0350.050-00054 ... M12 x 50 HDG 4.6 0350.050-00048 ... M12 x 50 A4-70 0350.050-00014	... M16 x 50 EP 4.6 0350.050-00069 ... M16 x 50 HDG 4.6 0350.050-00063
	2 3/8" [60]	... M10 x 60 EP 4.6 0350.050-00041 ... M10 x 60 A4-70 0350.050-00004	... M12 x 60 EP 4.6 0350.050-00055	... M16 x 60 EP 4.6 0350.050-00070 ... M16 x 60 HDG 8.8 0350.050-00065 ... M16 x 60 A4-50 0350.050-00026
	3 1/8" [80]	... M10 x 80 EP 4.6 0350.050-00043	... M12 x 80 EP 4.6 0350.050-00056	... M16 x 80 EP 4.6 0350.050-00071 ... M16 x 80 A4-50 0350.050-00027
	3 5/16" [100]	... M10 x 100 EP 4.6 0350.050-00044	... M12 x 100 EP 4.6 0350.050-00057	... M16 x 100 EP 4.6 0350.050-00072 ... M16 x 100 HDG 4.6 0350.050-00064 ... M16 x 100 A4-50 0350.050-00028
	5 7/8" [150]	... M10 x 150 EP 4.6 0350.050-00045	... M12 x 150 EP 4.6 0350.050-00059	... M16 x 150 EP 4.6 0350.050-00074 ... M16 x 150 A4-50 0350.050-00029

① Non-listed T-bolt sizes available on request. Contact your local Sales Representative for more information



HALFEN HTA ANCHOR CHANNELS

HALFEN HS 28/15 T-bolts

Nominal strength values												
T-bolt size	Material / Grade											
	4.6			8.8			A4-50			A4-70		
	N _{ss}	V _{ss}	M ⁰ _{ss}	N _{ss}	V _{ss}	M ⁰ _{ss}	N _{ss}	V _{ss}	M ⁰ _{ss}	N _{ss}	V _{ss}	M ⁰ _{ss}
	lbf [kN]	lbf [kN]	lbf-in [Nm]	lbf [kN]	lbf [kN]	lbf-in [Nm]	lbf [kN]	lbf [kN]	lbf-in [Nm]	lbf [kN]	lbf [kN]	lbf-in [Nm]
M8	2,967 [13.2]	1,980 [8.8]	133 [15.0]	-	-	-	-	-	-	-	-	-
M10	4,181 [18.6]	3,125 [13.9]	265 [29.9]	-	-	-	-	-	-	9,127 [40.6]	5,485 [24.4]	463 [52.3]
M12	4,946 [22.0]	4,540 [20.2]	464 [52.4]	-	-	-	-	-	-	-	-	-
Strength reduction factors ϕ												
	0.75	0.65	0.65	0.65	0.60	0.60	0.75	0.65	0.65	0.65	0.60	0.60

HALFEN HS 28/15 T-bolts – Selection of available T-bolts ①

	Length inch [mm]	Thread		
		M8 (5/16")	M10 (3/8")	M12 (1/2")
		HS 28/15 ...		
	1" [25]	... M8 x 25 EP 4.6 0350.020-00030	... M10 x 25 EP 4.6 0350.020-00043	-
	1 3/16" [30]	... M8 x 30 EP 4.6 0350.020-00031	... M10 x 30 EP 4.6 0350.020-00044	... M12 x 30 EP 4.6 0350.020-00057
	1 9/16" [40]	... M8 x 40 EP 4.6 0350.020-00032	... M10 x 40 EP 4.6 0350.020-00046	-
	1 15/16" [50]	-	... M10 x 50 A4-70 0350.020-00017	-
	2 3/8" [60]	... M8 x 60 EP 4.6 0350.020-00034	... M10 x 60 EP 4.6 0350.020-00048	-
	3 1/8" [80]	... M8 x 80 EP 4.6 0350.020-00035	... M10 x 80 EP 4.6 0350.020-00049	-
	3 15/16" [100]	... M8 x 100 EP 4.6 0350.020-00036	... M10 x 100 EP 4.6 0350.020-00050	-
	5 7/8" [150]	-	... M10 x 150 EP 4.6 0350.020-00052	-



① Non-listed T-bolt sizes available on request. Contact your local Sales Representative for more information

HALFEN HTA ANCHOR CHANNELS

HALFEN HTA Calculation Software

HALFEN HTA Software

The HALFEN calculation software for HALFEN HTA Anchor Channels with calculation according to ICC-ESR 1008 provides the user with a convenient and very powerful calculation tool.

Although HALFEN Anchor Channels could previously be selected from tables according to their load bearing capacity, AC232 requires a wider range of verifications for Anchor Channels and specified concrete. These verifications are processed by the user-friendly HALFEN software. In just a few seconds the user is presented with a list of suitable HALFEN HTA Anchor Channels for the relevant load situation.

Boundary conditions

The calculation takes into account all required loading parameters (e.g.):

- Cracked or non-cracked concrete
- The concrete components geometry, in particular the distances of the channel to the component edges
- Consideration of all service loads and applicable factored load combinations
- Positioning of the loads with a definable adjustment range, and the option of shifting the defined bolt pattern along the complete channel length

Input

The geometry and loads are entered interactively. Input values are displayed promptly in a 3D graphic and can also be edited directly in the graphic. Click on the load, specific dimension or component line to make the required modification.

Results

After calculation, the software output provides either the results for a pre-selected profile, or – in the case of automatic selection – a list of all suitable profiles. Profiles and T-bolts with incomplete verifications are high-lighted in red.



The software can be downloaded from the HALFEN website www.halfenusa.com



Screenshot 1: The HALFEN HTA Software start screen



Screenshot 2: Input GUI (Graphic User Interface), HALFEN HTA Software

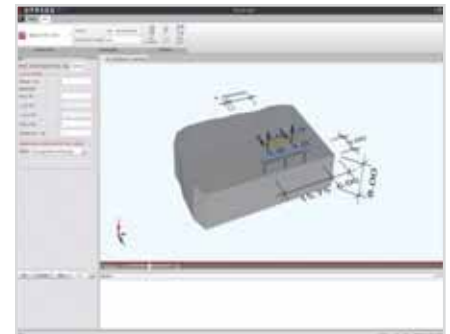

Screenshot 3: Inter-active 3D-display



Screenshot 4: Results list

HALFEN HTA ANCHOR CHANNELS

HALFEN HTA Calculation Software

HALFEN HTA Software

Visual control

All verifications for the current channel profile are listed in a tree structure. Green check-marks indicate successful verifications. Red check-marks indicate problem areas.

For further visual control a progress-bar on the right indicates the status of the verification process. Red bars indicate that a load has been exceeded while green bars indicate that the verifications meet the criteria.

Detailed calculation information (e.g. load positions, section sizes and utilization ratios) can also be selected within the tree structure.

After selecting a HALFEN Anchor channel and suitable T-bolts, the dimension results can be imported into the data list and saved.

Print-outs

Calculation reports are available in a brief summary form or a detailed version that can be placed into a calculation package. The detailed version provides all required verifications and individual capacities as well as a 2D graphical representation including applied loads.

The latest version of the dimensioning program is available for download on the internet at: www.halfenusa.com.

System requirements:

- Vista, Windows 7, Windows 8.x, Windows 10 with installed .NET Framework 3.5



Screenshot 5: Print preview



Screenshot 6: Print GUI

HALFEN HTA ANCHOR CHANNELS

Installation of Anchor Channels

Installation of HTA Anchor Channels

HALFEN Anchor Channels type HTA, ready for installation

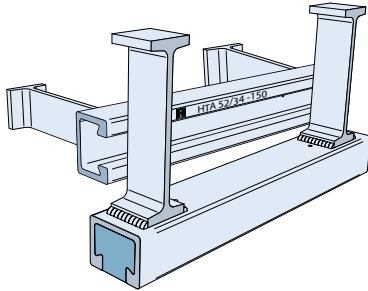

HALFEN Anchor Channels are supplied with pre-punched nail holes and a foam or strip filler. Any excess strip filler should be trimmed flush to the channel ends. Before fixing a HALFEN Anchor Channel to formwork, ensure that the profile, material, length, and the selected position is as specified in the plans. Fix the channels securely so that they remain flush with the surface of the formwork and will not be displaced when pouring the concrete. If the selected formwork is not suitable for nails use an alternative method for fixing. In top-of-slab applications make sure the top of the channel is flush with the final concrete surface.

⚠ Remove all steel packing straps from stainless steel HALFEN Anchor Channels immediately after delivery to prevent rust forming. Store the channels separately, with sufficient distance from dissimilar metals. Avoid damage to surface and contact corrosion caused by carbon steel. Store the channels in a dry, protected and well ventilated environment. Only use stainless steel fixing material (e.g. nails, screws etc.) with stainless steel anchor channels.

1. Preparations

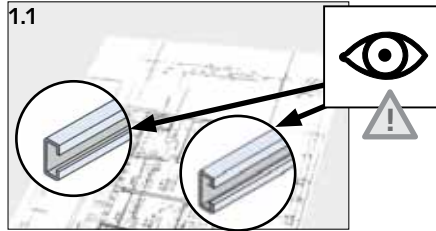

1.1 Select the HALFEN Anchor Channel according to the design plans.

2. Installation alternatives

Steel formwork

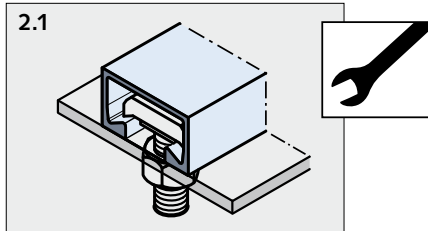

2.1 Secure with a HALFEN T-bolt through the formwork.

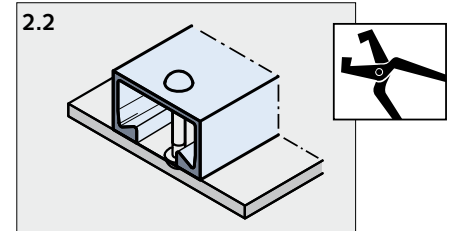

2.2 Using rivets or screws (supplied by the contractor) through the prepunched nail holes in the HALFEN Anchor Channel.

Timber formwork

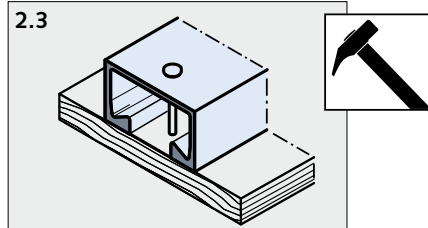

2.3 Fix to timber formwork with nails through the pre-punched holes in the back of the channel.

⚠ **Anchor Channels must be securely fastened** to ensure the lips are flush with the finished concrete surface. Incorrectly positioned channels will not achieve their full load capacity!

Top of slab installation

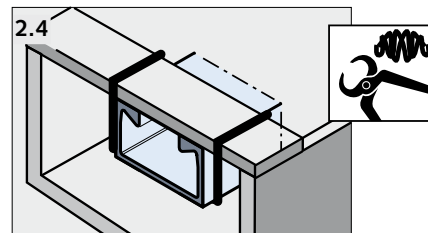

2.4 With a fixing bracket: Meticulous concrete compaction is essential to prevent air bubbles forming underneath the auxiliary work.

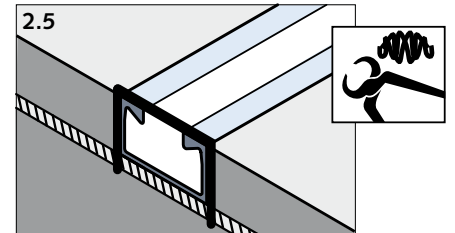

2.5 Fixing directly to the reinforcement: Attach the HALFEN Anchor Channel with reinforcement tie-wire.

HALFEN HTA ANCHOR CHANNELS

Installation of Anchor Channels

Metal pour stop

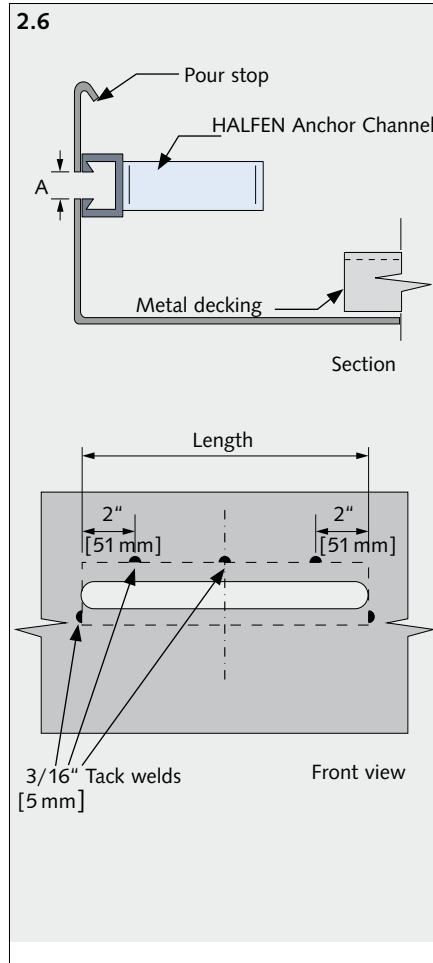

2.6 Securing HALFEN Anchor Channels to metal pour stops

1. Slotted pour stop: Pour stops at HALFEN Anchor Channel locations must be slotted. Slots should be pre-punched by the pour stop supplier. On-site cutting with a welding torch is not recommended. The slot width (dimension A) should be sized and cut to match the distance between the channel lips in the HALFEN Anchor Channel. Oversizing dimension A should be avoided.

2. Welding: Prior to welding, tightly clamp the HALFEN Anchor Channel in position over the slot in the pour stop (Figure 2.6). Care should be taken to ensure the channel is properly aligned with the slot.

To connect a HALFEN Anchor Channel up to 24" [610 mm] long to the pour stop, three 3/16" [5 mm] tack welds should be used along the top edge of the channel. A 3/16" [5 mm] tack weld should be used at the bottom lip at each end of the channel (refer to figure 2.6). American Welding Society Standard Specification ANSI/AWS provides guidelines for welding to 10-18 gauge galvanized steel (commonly used for pour stops).

After welding, the HALFEN Anchor Channel should be inspected to check it is firmly attached to the pour stop. Large welds or repeated welding should be avoided as this may damage the foam filler in the Anchor Channel. The pour stop should also be inspected after welding to ensure it has not been deformed.

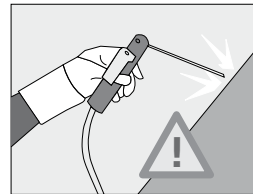

⚠️ Welding of galvanized steel components produces hazardous fumes. Appropriate precautions should be taken to ensure safe working conditions for those in the vicinity of the welding operation.

3. After concreting and striking the formwork

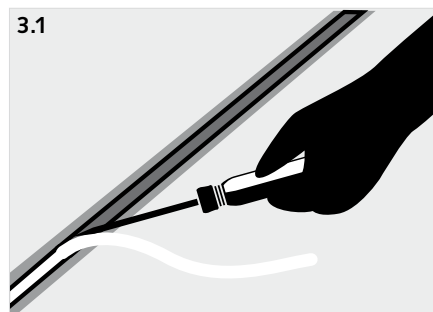

3.1 Remove filler using an appropriate tool, e.g. screwdriver.



For correct use of HALFEN T-bolts see the installation instructions for HALFEN T-bolts.

HALFEN HTA ANCHOR CHANNELS

Installation of HS T-bolts

4. Assembly sequence

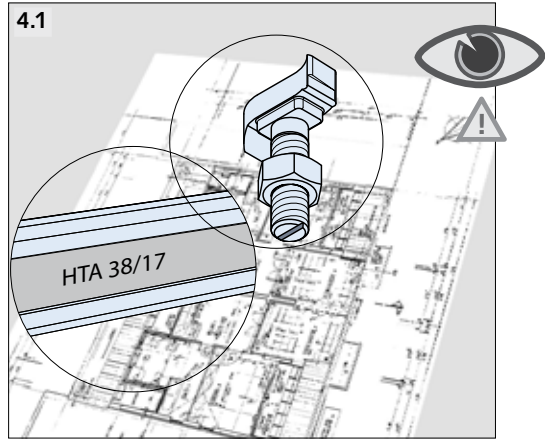

4.1 Select HALFEN T-bolt according to the planning documentation.

The installation torques provided in these assembly instructions apply only in conjunction with HALFEN HTA Anchor Channels.

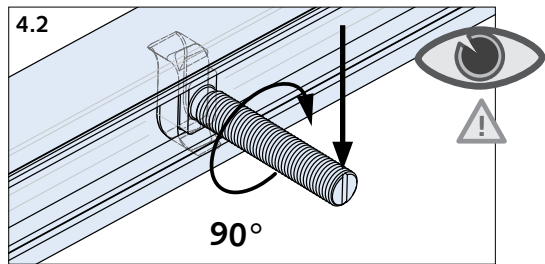

4.2 Insert the HALFEN T-bolt into the channel slot. After a 90° turn clockwise the HALFEN T-Bolt locks into position. (Check whether the notch is perpendicular to the longitudinal channel axis)

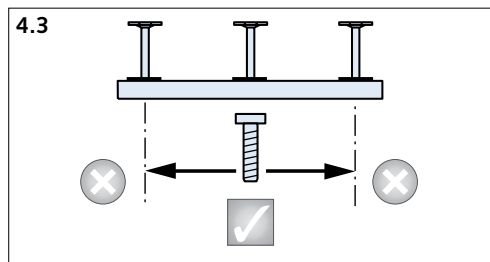

4.3 Alignment of the HALFEN T-bolt: It is not allowed to install HALFEN T-bolts beyond the center line of the end anchors.

5. Installation torques

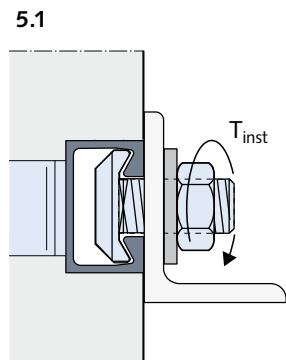

Tighten the nut with the installation torque T_{inst} according to the table on page 30. Exceeding the given

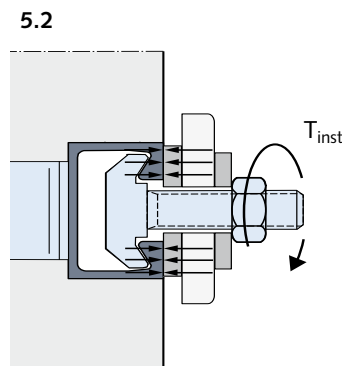

installation torque T_{inst} according to this table may damage the connections and reduce the capacity.

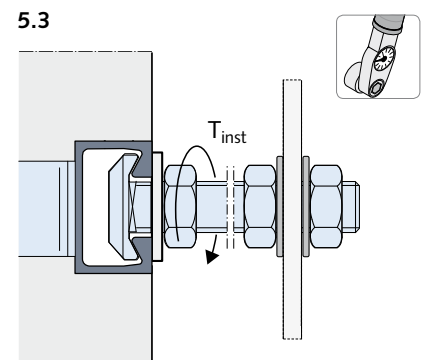

Figure 5.1 shows the general case; Figure 5.2 and 5.3 show the steel-steel contact case (explanation see next page).

HALFEN HTA ANCHOR CHANNELS

Installation of HS T-bolts

Position of structural attachment:

General:
The fixture presses directly against concrete and/or to the HALFEN Anchor Channel.

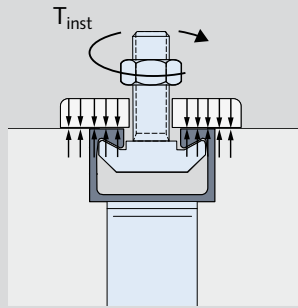

Steel – steel contact:
The fixture presses against the HALFEN Anchor Channel via a suitable shim.

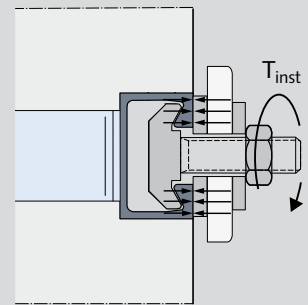

Installation torque HALFEN HS T-bolts in combination with HALFEN HTA Anchor Channel

Condition of the fixture	Strength class	HALFEN Anchor Channel	T_{inst} lbf-ft [Nm]															
			M8		M10		M12		M16		M20		M24		M27		M30	
General	Steel 4.6/8.8	28/15	5	[7]	9	[12]	12	[16]										
		38/17			10	[14]	14	[19]	30	[40]								
		40/22			11	[15]	18	[25]	48	[65]								
	Stainless steel 50/70	50/30			11	[15]	18	[25]	48	[65]	85	[115]						
		52/34			11	[15]	18	[25]	48	[65]	100	[135]						
		55/42			11	[15]	18	[25]	48	[65]	100	[135]	170	[230]				
		72/48									100	[135]	170	[230]	251	[340]	339	[460]
Steel 4.6	28/15	5	[7]	10	[13]	13	[18]											
	38/17			12	[16]	17	[23]	44	[60]									
	40/22			12	[16]	21	[28]	48	[65]									
	50/30			12	[16]	21	[28]	52	[70]	100	[135]	170	[230]					
	52/34			12	[16]	21	[28]	52	[70]	100	[135]	170	[230]					
	55/42			12	[16]	21	[28]	52	[70]	100	[135]	170	[230]					
	72/48									100	[135]	170	[230]	251	[340]	339	[460]	
Steel – steel contact	Steel 8.8	28/15																
		38/17					48	[65]	100	[135]								
		40/22					30	[40]	55	[75]	136	[185]						
	50/30					30	[40]	55	[75]	136	[185]	266	[360]	461	[625]			
	52/34					30	[40]	55	[75]	136	[185]	266	[360]	461	[625]			
	55/42					30	[40]	55	[75]	136	[185]	266	[360]	461	[625]			
	72/48									266	[360]	461	[625]	664	[900]			
Stainless steel 50	28/15																	
	38/17							33	[45]									
Stainless steel 70	28/15	11	[15]	22	[30]													
	38/17			22	[30]	30	[40]											

6. Final installation check of assembly

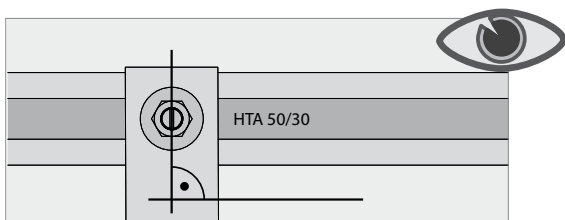

6. After tightening the nut, check whether the T-bolt is properly installed. If the notch is not perpendicular to the longitudinal channel axis, the T-bolt must be completely loosened, re-aligned, re-tightened; finally re-check the orientation of the notch is now correct.

HALFEN HTA ANCHOR CHANNELS

Engineering Form

Project Information

Please complete the form below and send to engineering@halfenusa.com or your HALFEN Sales Representative.
Please visit www.halfenusa.com to find the sales representative for your state.

Project Information

Project name: _____ City, State, ZIP: _____

Project address: _____

Building type: (optional) _____

Contact Information

Company name: _____ City, State, ZIP: _____

Contact Person: _____ Business type: _____

Email: (optional) _____

Channel criteria

Channel length, L (inch)			
End distance, $x_{cbh,1}$ (inch)			
Edge spacing (inch)			
$c_{a1,1}$:			
$c_{a1,2}$:			
$e_{a2,1}$:	$e_{a2,2}$:		
Slab thickness, h (inch)			
	T-bolt 1	T-bolt 2	T-bolt 3
T-bolt spacing, s_b (inch)			
Tension load, N_{ua}^b (lbf)			
Shear load, V_{ua}^b (lbf)			
Concrete strength, f_c' (psi)			
Additional comments			

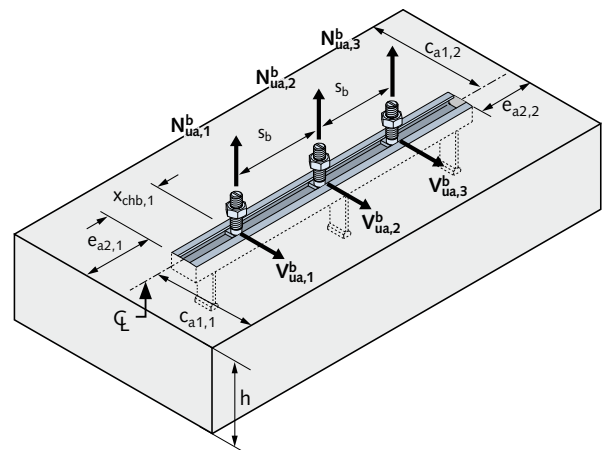

CONTACT HALFEN WORLDWIDE

HALFEN has a global network of Subsidiary Companies to assist you. The main contact information for North America and the European Headquarters is provided below. For a full list of offices please visit www.HALFEN.com

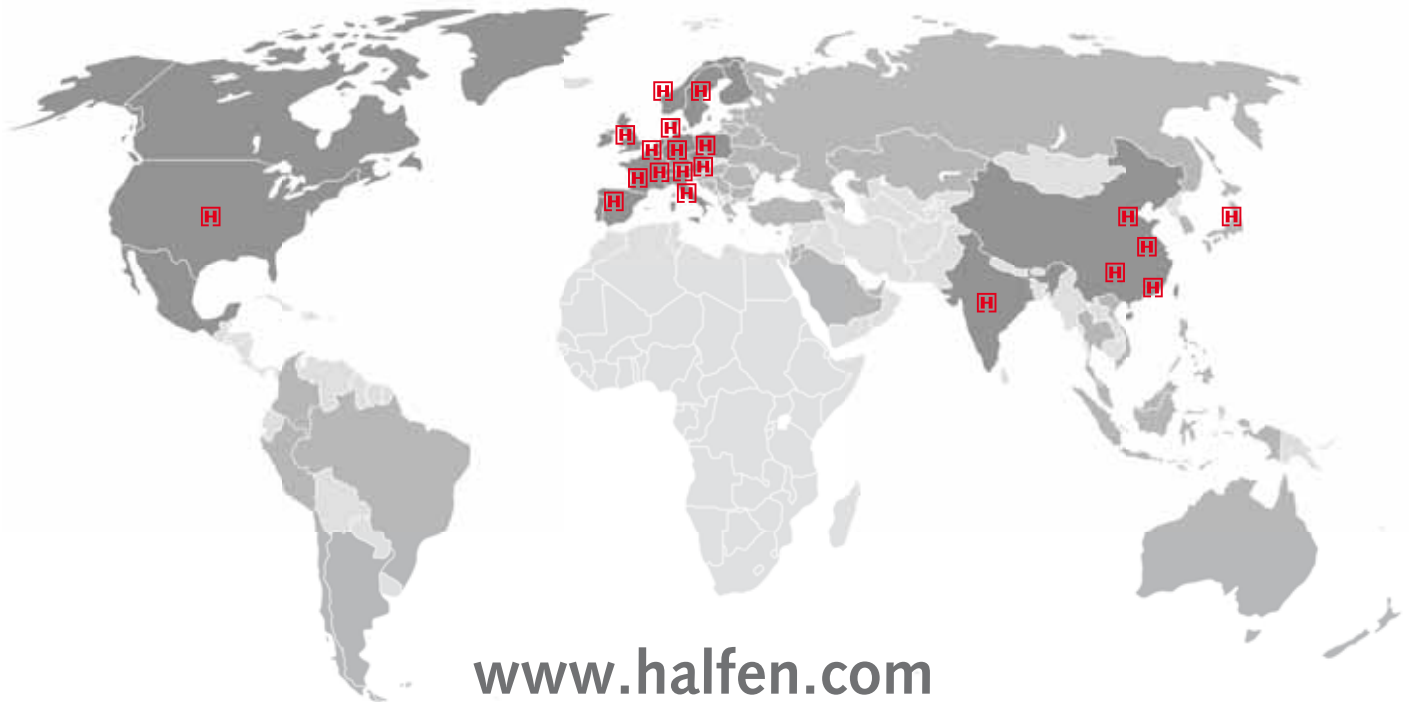

USA & Mexico	HALFEN USA Inc. 4965 Eisenhower, Suite 101 Windcrest, TX 78218	Phone: +1 800.423.9140 E-Mail: info@halfenusa.com Web: www.halfenusa.com	Fax: +1 877.683.4910
Canada	UCC Industries International (Distributor) Units 12 & 13 895 Sandy Beach Road Pickering, Ontario, L1W 3N7 Provinces of British Columbia and Alberta:	Phone: +1 905.831.7724 E-Mail: bhughes@ucci.ca Web: www.ucci.ca Please contact HALFEN USA Inc.	Fax: +1 905.831.5872
Germany	HALFEN GmbH Liebigstrasse 14 40764 Langenfeld	Phone: +49 2173 970-0 E-Mail: info@halfen.de Web: www.halfen.de	Fax: +49 2173 970-123

HALFEN is also represented by distributors in Argentina, Australia, Azerbaijan, Belarus, Brazil, Bulgaria, Chile, China, Colombia, Croatia/Bosnia-Herzegovina/FYROM/Montenegro, Cyprus, Estonia, Greece, Hong Kong, Hungary, India, Indonesia, Ireland, Israel, Japan, Jordan, Kingdom of Saudi-Arabia, Latvia, Lebanon, Lithuania, Luxembourg, Malaysia, Malta, Mexico, New Zealand, Peru, Philippines, Republic of Kazakhstan, Romania, Russia, Serbia, Singapore, Slovenia, Spain, South Korea, Taiwan/ROC, Thailand, Turkey, Ukraine, United Arab Emirates, Uruguay, Vietnam

HALFEN GmbH shall not accept liability for the accuracy of the information in this publication or for any printing errors.

